



JOCT357Xk-M4 Series

Rev.A.1.0

DESCRIPTION:

The products are transistor output opto-couplers in a plastic SOP4 package. The device which is infrared LED chip and Photo-transistor chip are assembled on lead frame, in order to change the electricity-light-electricity. The products are widely used in transmission and conversion of digital logic, power control and switch, electric insulation and impedance conversion between circuits systems.



MAIN FEATURES

- High isolation 3750 VRMS
- Operating temperature range -55°C to 110°C
- RoHS & REACH Compliance
- HBM: H3A; MM: M4; CDM:C3
- CQC approved
- VDE approved
- UL approved

ABSOLUTE MAXIMUM RATINGS (Temperature=25°C)

Parameter		Symbol	Value	Unit
Input	Forward Current	I_F	50	mA
	Peak Forward Current	I_{FP}	1	A
	Reverse Voltage	V_R	6	V
	Power Dissipation	P_D	75	mW
Output	Collector-emitter Voltage	V_{CEO}	40	V
	Emitter-collector Voltage	V_{ECO}	7	V
	Collector Current	I_C	50	mA
	Power Dissipation	P_C	150	mW
Total Power Dissipation		P_{tot}	225	mW
Isolation Voltage		V_{iso}	3750	Vrms
Operating Temperature		T_{opr}	-55~+110	
Junction Temperature		T_j	125	



Storage Temperature	T _{stg}	-55~+125	
Soldering Temperature	T _{sol}	260	

NOTE1: 100μs pulse, 100Hz frequency

NOTE2 AC for 1minute, R.H.=40~60%

ELECTRICAL CHARACTERISTICS (Temperature=25°C)

Parameter	Symbol	Condition	Min.	Typ 1
-----------	--------	-----------	------	-------



ORDERING INFORMATION

<p>J</p> <p>JieJie Microelectronics Co., Ltd.</p>	<p>OC</p> <p>Opto Coupler</p>	<p>T</p> <p>Transistor</p>	<p>357</p> <p>Marketization Model</p>	<p>B</p> <p>CTR Rank:D/None</p>	<p>k</p> <p>k: Medium-speed</p>	<p>-M4</p> <p>SOP4</p>	<p>/</p> <p>None:T1 R:T2</p>
--	--------------------------------------	-----------------------------------	--	--	--	-------------------------------	---

Packing Quantity	
Option	Quantity
None/R	3000 Units/Reel

MARKING



Characteristics Curves

FIG.1: Max. Allowable LED Forward Current vs. Ambient Temperature

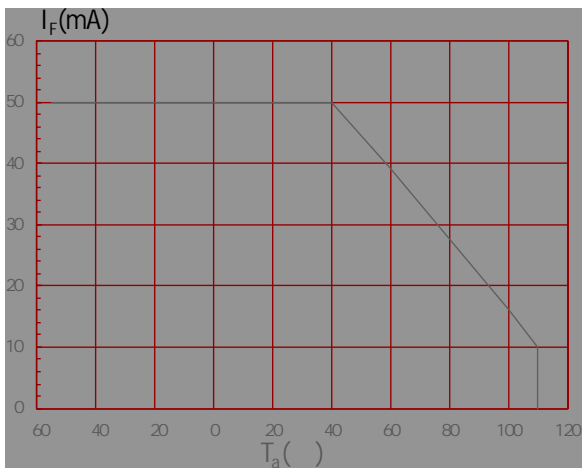

FIG.2: Collector Power Dissipation vs. Ambient Temperature

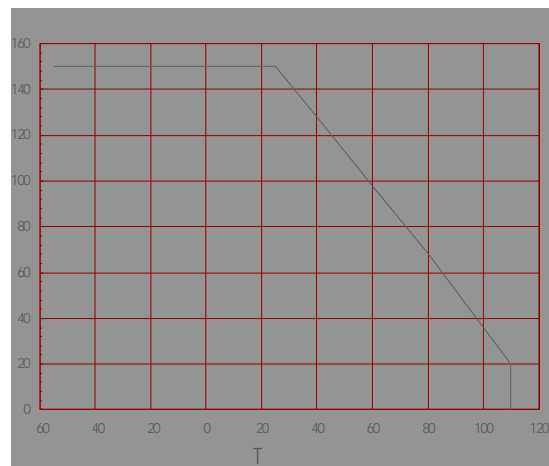

FIG.7: Current Transfer Ratio vs. Forward Current

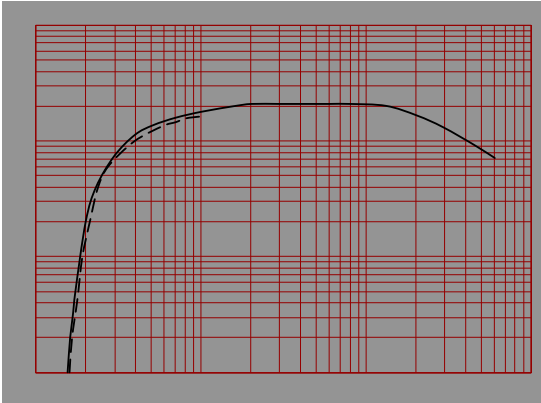
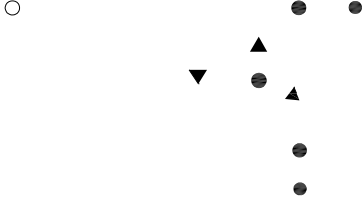

FIG.8: Normalized Collector-emitter Saturation Voltage vs. Ambient Temperature

Test Circuits

FIG.13: Test Circuits of Propagation Delay Time

FIG.14: Curves of Propagation Delay Time



Package Dimension (Unit: mm)

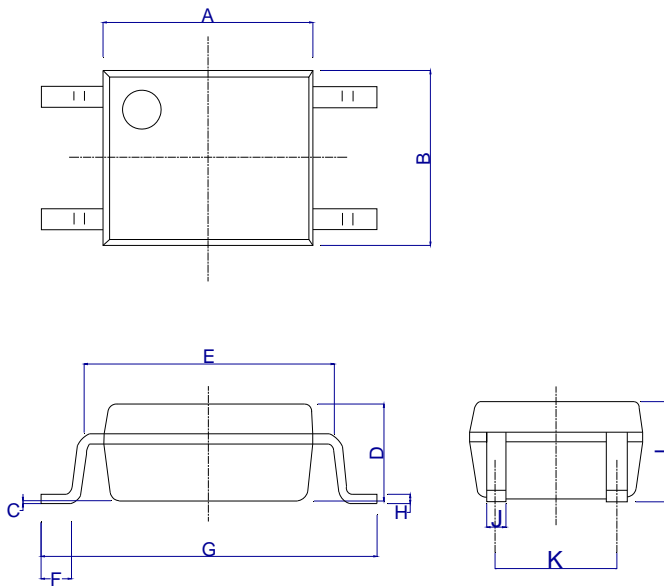

Ref.	Dimensions					
	Millimeters			Inches		
	Min.	Typ.	Max.	Min.	Typ.	Max.
A	4.40		4.80	0.173		0.189
B	3.60		4.20	0.142		0.165
C	0.00		0.20	0.000		0.008
D	1.90		2.30	0.075		0.091
E	5.00		5.60	0.197		0.220
F	0.34		0.94	0.013		0.037
G	6.70		7.30	0.264		0.287
H	0.10		0.30	0.004		0.012
I	2.00		2.40	0.079		0.094
J	0.25		0.55	0.010		0.022
K	2.29		2.79	0.090		0.110

RECOMMENDED SOLDER MASK (Dimensions in mm unless otherwise stated)

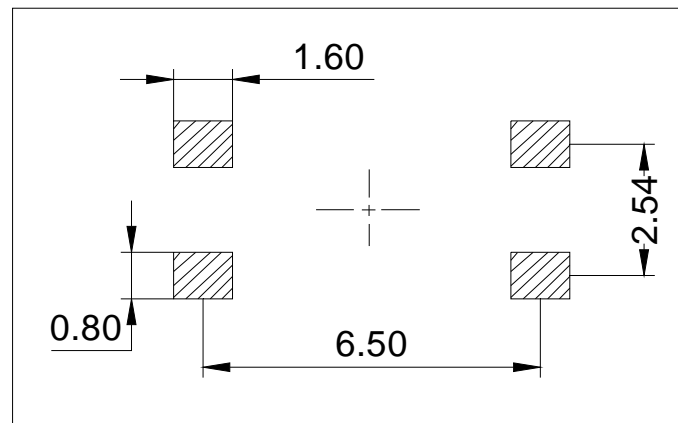

CARRIER TAPE SPECIFICATIONS (Dimensions in mm unless otherwise stated)

Option None

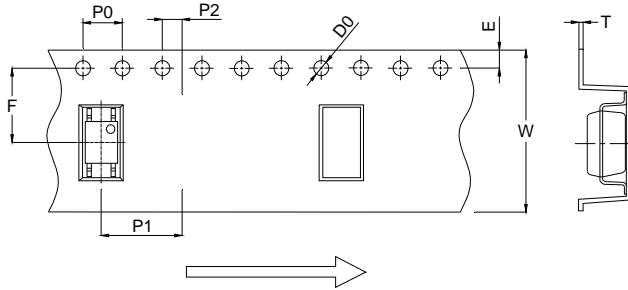

Ref.	Dimensions					
	Millimeters			Inches		
	Min.	Typ.	Max.	Min.	Typ.	Max.
D0						
P0						
P1						
P2						
E						
F						
T						
W						

REFLOW INFORMATION

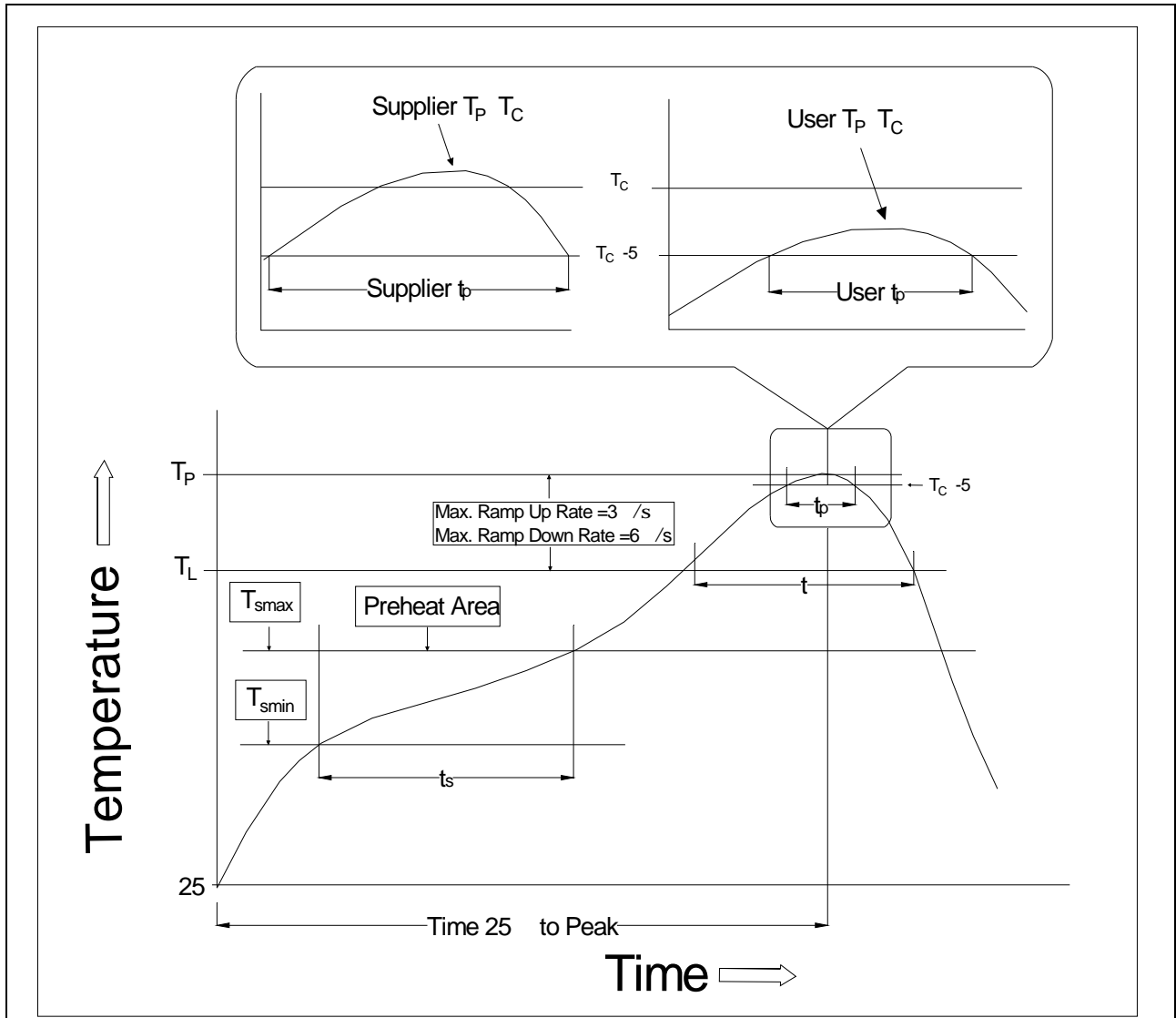

Profile Feature	Sn-Pb Assembly Profile	Pb-Free Assembly Profile
Temperature Min. (T _{smin})	100	150
Temperature Max. (T _{smax})	150	200
Time (t _s) from (T _{smin} to T _{smax})	60-120 seconds	60-120 seconds
Ramp-up Rate (t _L to t _P)	3 °/second max.	3 °/second max.
Liquidus Temperature (T _L)	183	217
Time (t _L) Maintained Above (T _L)	60-150 seconds	60-150 seconds
Peak Body Package Temperature	235 +0 /-5	260 +0 /-5

Note:

1. Reflow soldering is recommended at the temperatures and times shown, no more than three times.
2. Avoid direct contact between the epoxy body and any tools or surfaces exceeding its maximum storage temperature.
3. Application of pressure on the epoxy body is prohibited at elevated temperatures. In specific scenarios, any applied force must not exceed 2.5N.
4. Ensure the component has cooled to ambient temperature before proceeding with any subsequent manufacturing steps.
5. The component has a shelf life of one year when stored under standard conditions.
6. Recommend storage Temp.: 0~40°C;
Recommend storage humidity: <60%;
MSL level: MSL 1

Information furnished in this document is believed to be accurate and reliable. However, Jiangsu JieJie Microelectronics Co., Ltd. assumes no responsibility for the consequences of use without consideration for such information nor use beyond it. Information mentioned in this document is subject to change without notice, apart from that when an agreement is signed, Jiangsu JieJie complies with the agreement.

Products and information provided in this document have no infringement of patents. Jiangsu JieJie assumes no responsibility for any infringement of other rights of third parties which may result from the use of such products and information. This document supersedes and replaces all information previously supplied.



is a registered trademark of Jiangsu JieJie Microelectronics Co., Ltd.

Copyright © 2026 Jiangsu JieJie Microelectronics Co., Ltd. All rights reserved.