

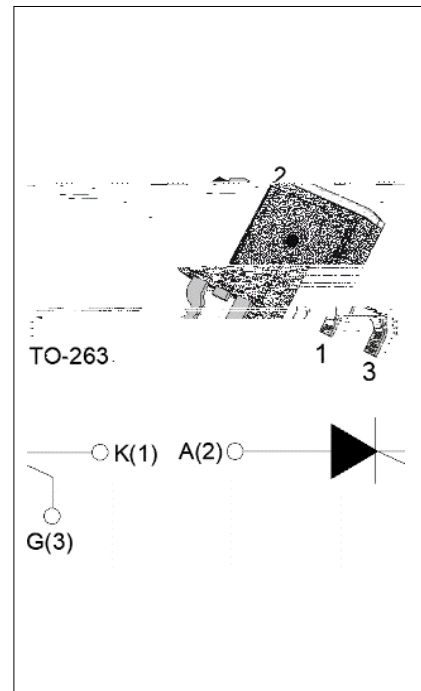

DESCRIPTION:

With high ability to withstand the shock loading of large current, JCT151E-650RH of silicon controlled rectifiers provides high dV/dt rate with strong resistance to electromagnetic interference. It is especially recommended for use on solid state relay, motorcycle, power charger, T-tools etc. Package TO-263 is RoHS compliant.



MAIN FEATURES

Symbol	Value	Unit
$I_{T(RMS)}$	12	A
V_{DRM}/V_{RRM}	650	V
I_{GT}	15	mA

ABSOLUTE MAXIMUM RATINGS

Parameter	Symbol	Value	Unit
Storage junction temperature range	T_{stg}	-40-150	
Operating junction temperature range	T_j	-40-150	
Repetitive peak off-state voltage ($T_j=25$)	V_{DRM}	650	V
Repetitive peak reverse voltage ($T_j=25$)	V_{RRM}	650	V
Average on-state current ($T=128$)	$I_{T(AV)}$	7.5	A
RMS on-state current ($T=128$)	$I_{T(RMS)}$	12	A
Non repetitive surge peak on-state current ($t_p=10ms, T_j=25$)	I_{TSM}	120	A
Non repetitive surge peak on-state current ($t_p=8.3ms, T_j=25$)		132	
I^2t value for fusing ($t_p=10ms, T_j=25$)	I^2t	72	A^2s
Critical rate of rise of on-state current ($I_G=2 \times I_{GT}, f=100Hz, j=150$)	di/dt	100	A/s
Peak gate current ($t_p=20s, T_j=150$)	I_{GM}	4	A

JCT151E-650RH

Jie Jie

ORDERING INFORMATION

J CT 151 E -650

FIG.1: Maximum power dissipation versus RMS on-state current

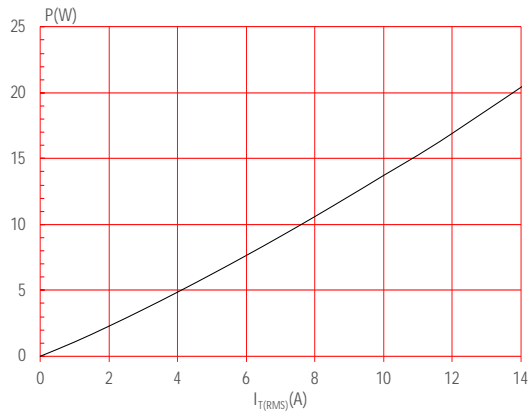

FIG.2: RMS on-state current versus case temperature

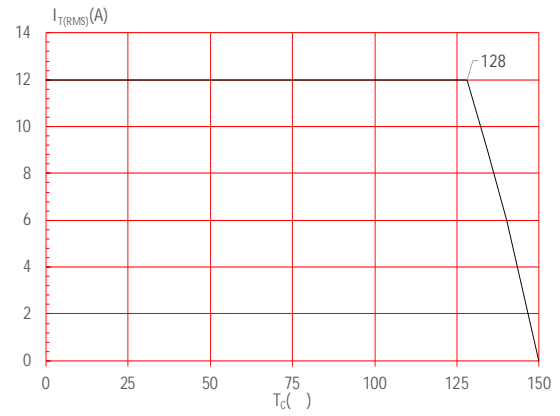

FIG.3: RMS on-state current versus ambient temperature (printed circuit board FR4,copper)

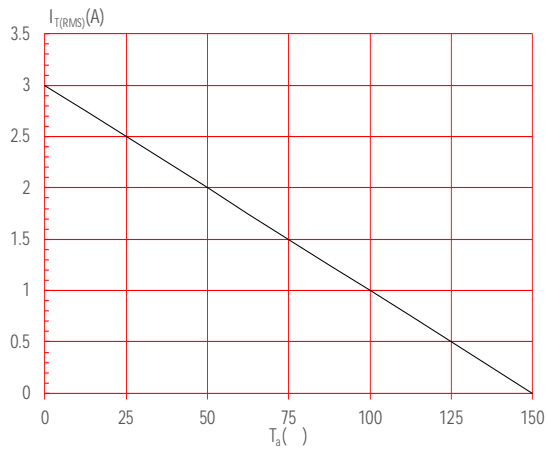

FIG.4: Surge peak onstate current versus number of cycles

FIG.7: Relative variations of gate trigger current, holding current and latching current versus junction temperature

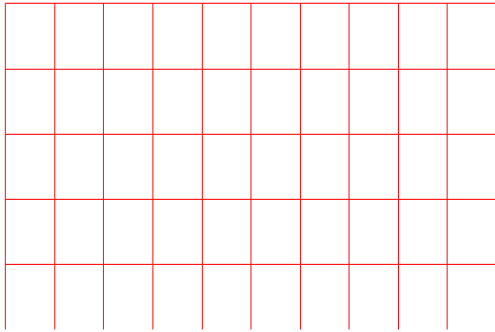
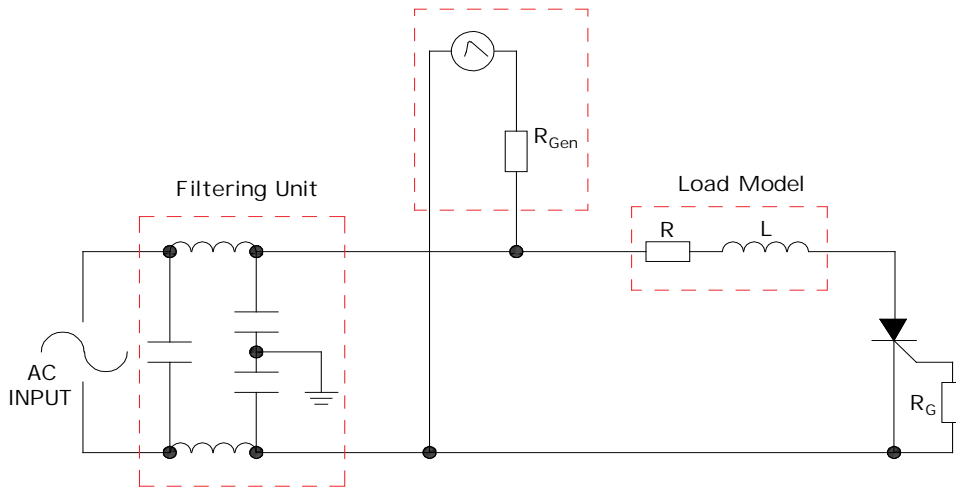

FIG.8 Test circuit for inductive and resistive loads to IEC61000-4-5 standards.

IEC61000-4-5 Standards
Surge Generator



SOLDERING PARAMETERS

Reflow Condition		Pb-Free assembly (see figure at right)
Pre Heat	-Temperature Min ($T_{s(min)}$)	+150
	-Temperature Max($T_{s(max)}$)	+200
	-Time (Min to Max) (ts)	60-180 secs.
Average ramp up rate (Liquidus Temp(T_L) to peak)		3 /sec. Max
$T_{s(max)}$ to T_L -Ramp-up Rate		3 /sec. Max
Reflow	-Temperature(T) (Liquidus)	+217
	-Temperature(t)	60-150 secs.
Peak Temp (T_p)		+260(+0%)
Time within 5 of actual Peak Temp (t)		20-40secs.
Ramp-down Rate		6 /sec. Max

9 SCN (m)4. Mo2P5.66 Pe23 T78.91(0)8.918.S Q q8im

JCT151E-650R

 Jie Jie Microelectronics Co., Ltd.

ORDERING INFOR

Order code

DELIVERY MODE



Information furnished in this document is believed to be accurate and reliable. However, Jiangsu JieJie Microelectronics Co., Ltd. assumes no responsibility for the consequences of use without consideration for such information nor use beyond it. Information mentioned in this document is subject to change without notice, apart from that when an agreement is signed, Jiangsu JieJie complies with the agreement. Products and information provided in this document have no infringement of patents. Jiangsu JieJie assumes no responsibility for any infringement of other rights of third parties which may result from the use of such products and information. This document supersedes and replaces all information previously supplied.

 is a registered trademark of Jiangsu JieJie Microelectronics Co., Ltd.
Copyright ' 2025 Jiangsu JieJie Microelectronics Co., Ltd. All rights reserved.